

All The Buzz: Erlang at CloudBees

Garrett Smith

Erlang User Conference, Stockholm

2011/11/03



CloudBees

Future of Civilization

What Is The Cloud?



A Network Symbol

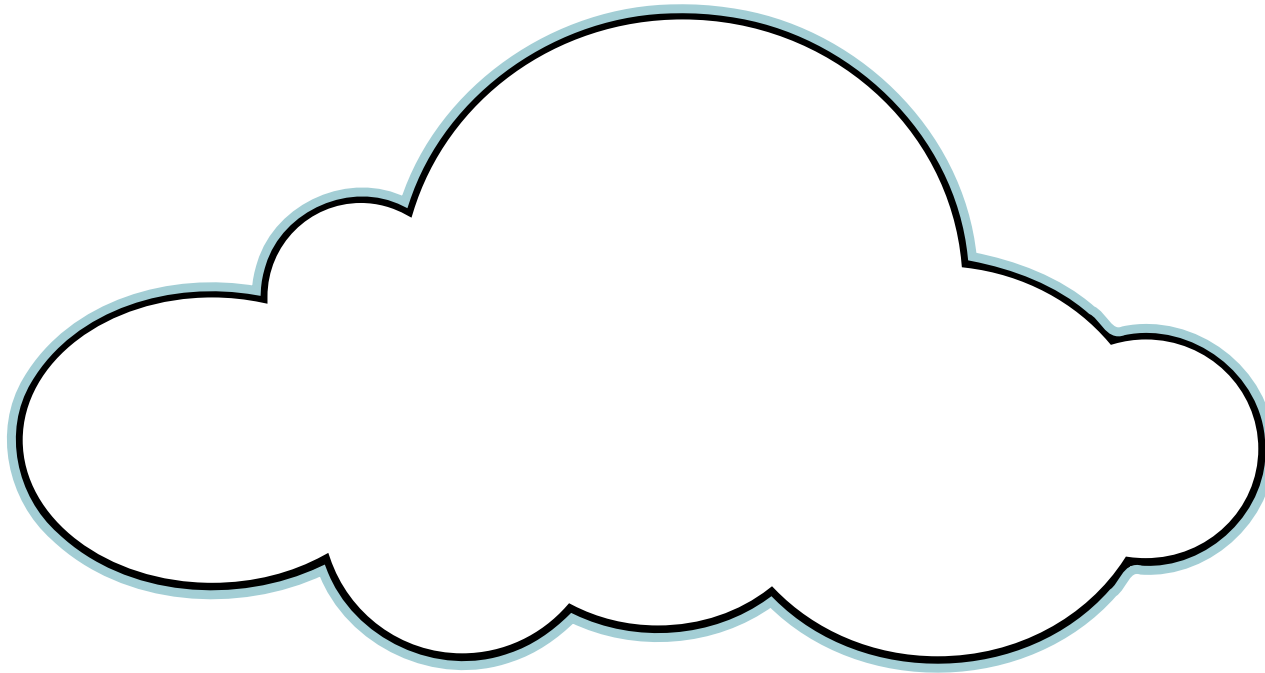

An Abstraction

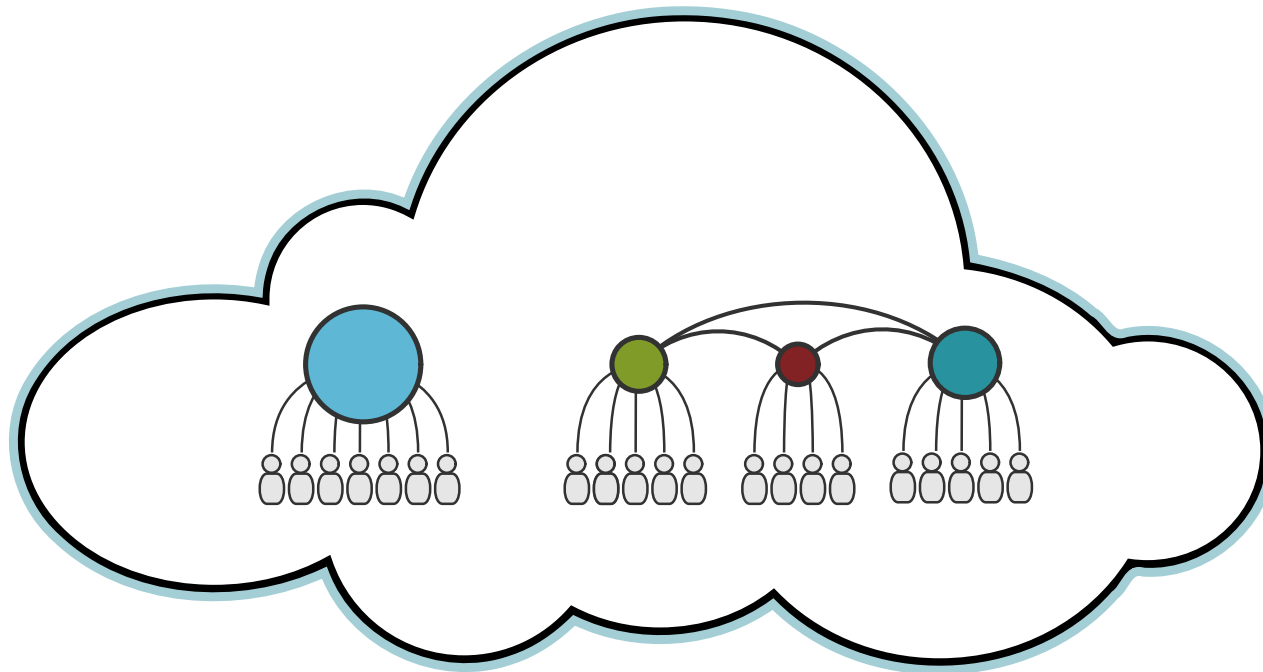

Something Said On TV



Other Opinions



Why Cloud?

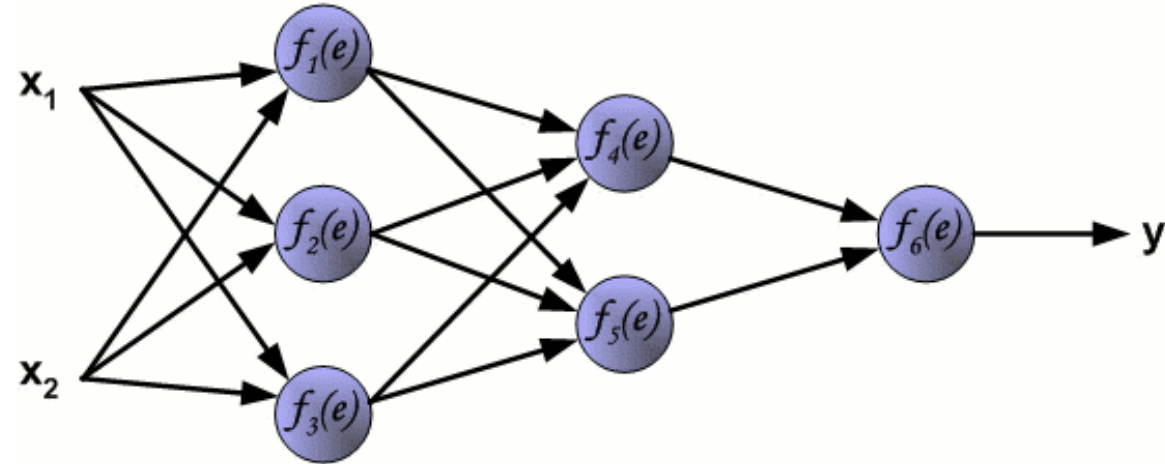

Seriously, Why?



Lars “The Cloud” Olsson



The Cloud



Fixed Costs, Bad

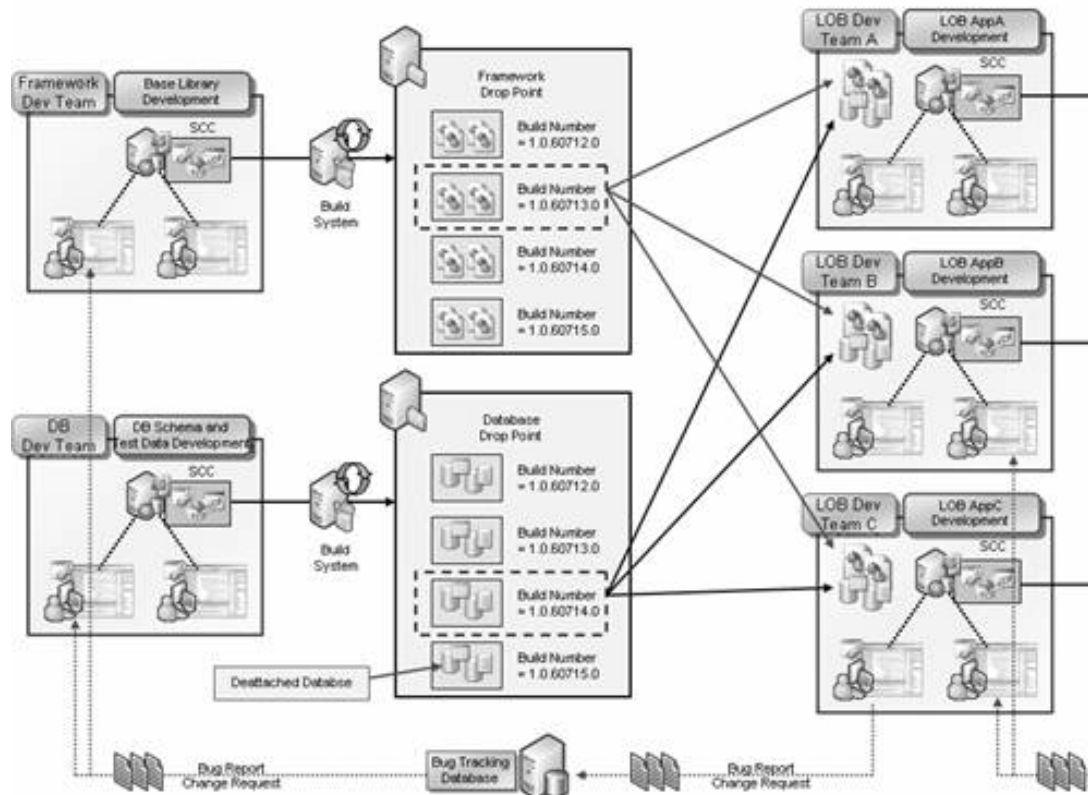

Fixed Costs, Big



Fixed Costs, Removed



Small Rapid Change, Good

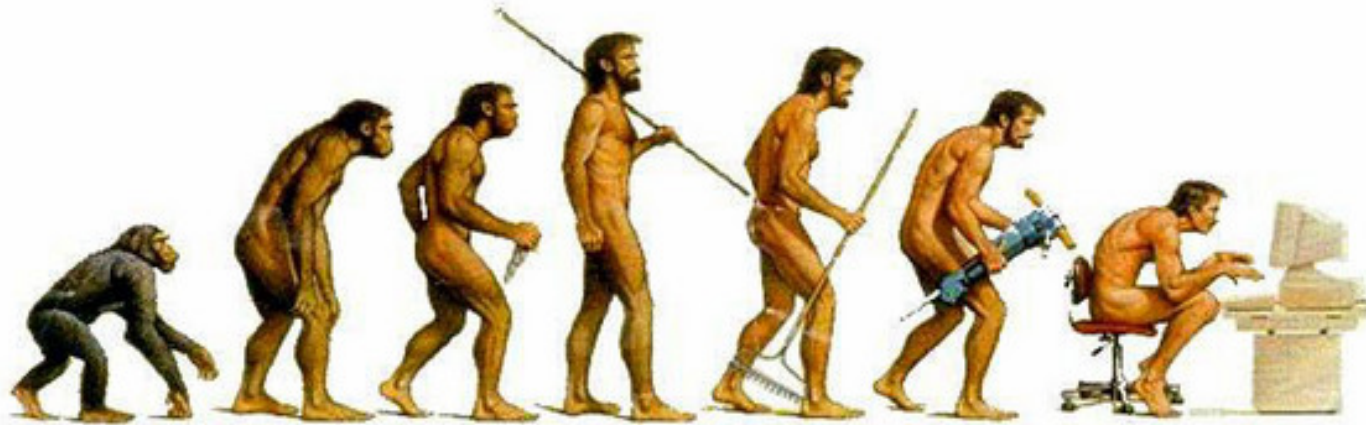

About CloudBees



CloudBees



Read And Agree

The Java and MySQL logos are registered trademarks of Oracle and/or its affiliates



Service Oriented, Multi Language

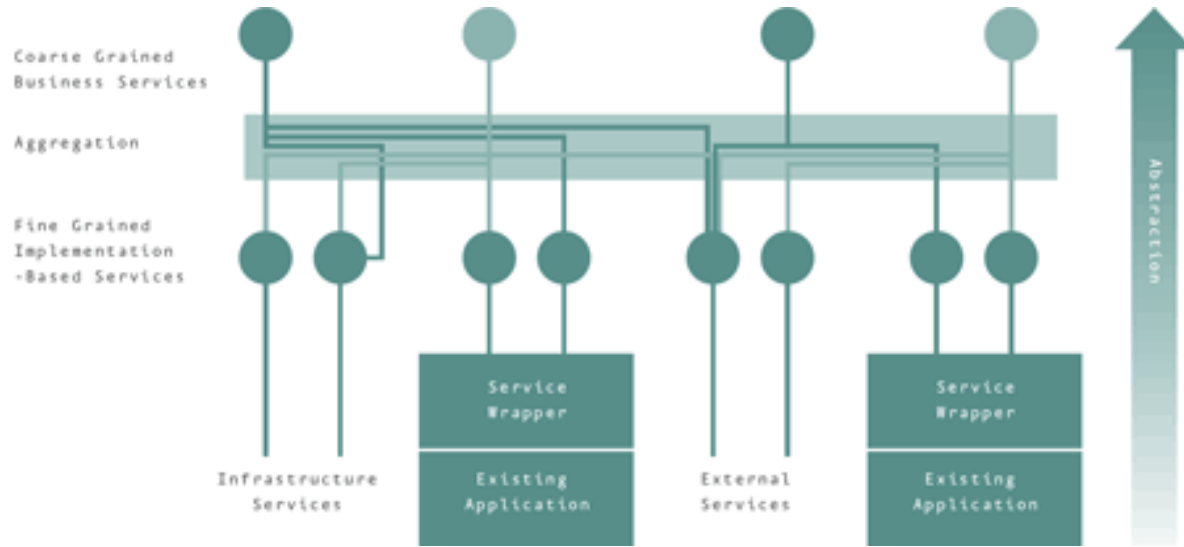

Java™

Scala

ERLANG



Ruby

python™

Read And Agree

The Java logo is a registered trademark of Oracle and/or its affiliates



Messaging

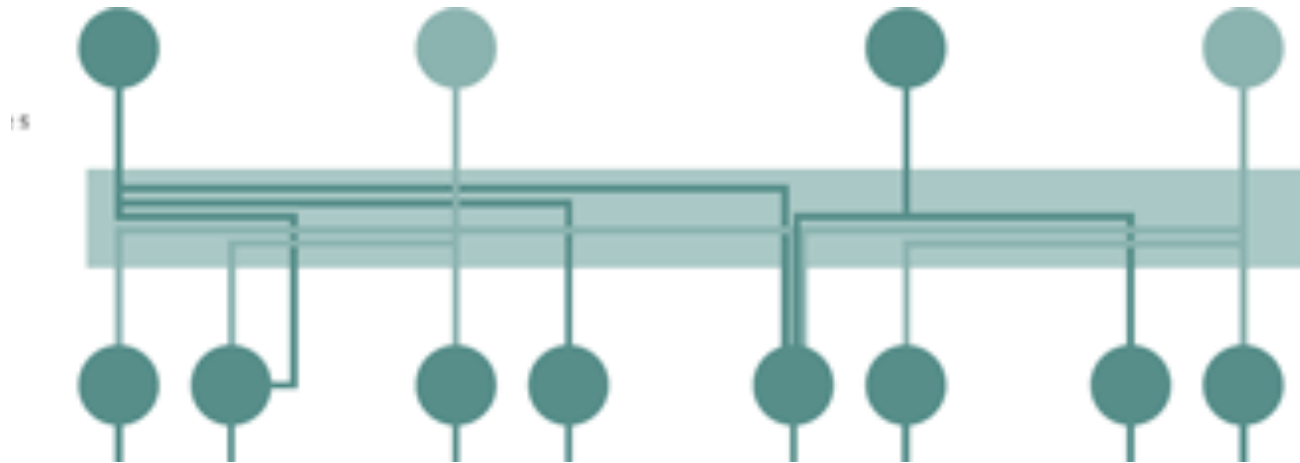

Why Erlang?



The Result



Another Result

Decomposition

Fail Fast

Dependencies

Start Semantics

Service Design

Cost of State



What Sucks About Erlang

Basic Syntax

If Expressions

Strings

Functional Programming Mismatch

Records

Code Organization

Uneven Libraries and Documentation



The Actual Problem



And Also



Tools!



Tak!

Q/A



CloudBees